

THE PRESSURE REDUCING VALVE SPECIALIST



Customized **solutions**
for your business.



COMFORTABLE AND ENVIRONMENTALLY CONSCIOUS – WITH SAFETY!



Water. Everyone almost takes it for granted, and yet clean and pure drinking water is our most precious commodity - our elixir of life. Many people work to obtain it and supply it to our cities, using a wide variety of technologies. The protection of our water is particularly important so that we can continue to be supplied with clean drinking water everywhere in the future.

With our pressure reducing valves, we at Goetze have stood for responsible and reliable water management for almost 75 years! Since our foundation in 1949, pressure reducing valves in water applications and in building services engineering have remained one of our most important business areas. Our rich experience results in innovative solutions.

Safety and protection go hand in hand with Goetze pressure reducing valves. The protection of people and the environment is guaranteed by the materials approved in accordance with the recognised regulations, such as lead-free gunmetal or plastic from medical technology. According to the Drinking Water Ordinance, only materials that are expressly suitable for drinking water may be used for the construction and maintenance of drinking water installations. They must not adversely alter the water, change the smell or taste of the water or release substances into the drinking water in avoidable concentrations. These requirements are met by our materials, thus protecting the user and the environment.



BUILDINGS



POTABLE WATER PURIFICATION



INDUSTRIAL KITCHENS



SPRINKLER SYSTEMS

NEWS · NEWS · NEWS · NEWS

SERIES 9160

Special variants for use with Water dispensers with fixed water connection

Water dispensers with a fixed water connection are very much in vogue: they dispense tasty drinking water - chilled, unchilled or carbonated and at the same time make a valuable contribution to environmental protection. There is no more efficient way to transport water than via the mains. The water does not have to be bottled and transported to its destination by lorry. This saves plastic waste and CO2!

In order to protect the device from excessive supply pressure and to ensure the appropriate operating pressure, water dispensers are equipped with pressure reducing valves.

Goetze is your partner in terms of pressure here too. With the 9160 series, the smallest water pressure reducing valve in the Goetze portfolio, we have the right pressure reducing valve for your water dispenser. The integrated filter screen protects the water dispenser and the installation from particles and impurities. An adjustment scale in the bonnet allows pressureless presetting with a screwdriver. The housing is made of mentzinc-plated brass - also available in lead-free brass on request.

To make installation as convenient as possible, the pressure reducing valve of the 9160 series in DN8 is also available with pre-assembled hose connectors. For the connection of flexible hoses, the variant with 3/8" external thread is available. This means that there is no need for separately mounted fittings and the pressure reducing valve can be mounted directly.

According to DIN EN 1717, a water dispenser (without fine filter / activated carbon filter) must be secured with a class 2 safety device. Here too, there is a solution from Goetze, in which a backflow preventer type EA is integrated in the housing of the pressure reducing valve. This means that the backflow preventer does not have to be mounted as a separate component.

A pressure gauge with PTFE ring is optionally available. This is simply screwed into position and does not need to be sealed with hemp or teflon tape.



version A32-2

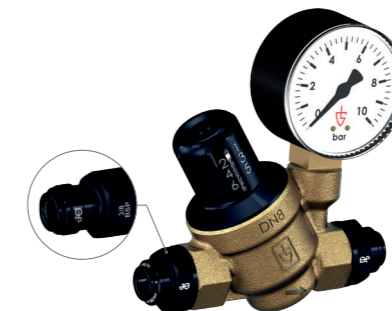

version A32-1



version m/m S17

SERIES 9000



+ ADVANTAGES OF THIS SERIES

lead-free gunmetal housing

high-quality plastic

flow optimisation permits a higher maximum flow rate

160 µm fine screen insert

transparent filter cup

setting scale visible from two angles

Pressure reducing valve

made of lead-free gunmetal, with threaded connections

The first Goetze fitting with functional parts made of plastic has been developed for the environmentally-aware and health-conscious user.

The lead-free pressure reducing valve housing does not release any harmful substances into the potable water and is corrosion-resistant for all water qualities. At the same time, the avoidance of heavy metals protects the environment.

The valve insert is made of a high-quality plastic from the medical technology sector, and offers convincing cavitation-, temperature- and media-resistance. The flow rate of the pressure reducing valve has also been rated for maximum output - flow optimisation permits a higher maximum flow rate and physical effects in the valve can create a higher flow rate with the same pressure drop.

The integrated 160 µm fine screen insert protects the fitting and downstream installation from dirt particles and is easy to clean without the valve insert having to be removed and the output pressure reset. The degree of contamination can be seen through the transparent filter cup.

Another feature is the setting scale visible from 2 angles. This makes the setting process even more convenient by displaying the current set pressure in every position. This means that the setting can also be made without a pressure gauge, special tool or operating pressure.

 **Temperatures**
from +5°C to +85°C

 **Inlet pressure up to 25 bar, Outlet pressure adjustable**
from 0,5 bar to 12 bar

 **Threaded connections**
from ½" to 2"

Simple and convenient: Watch step by step how to pressure adjustment and maintenance of the pressure reducer series 9000.

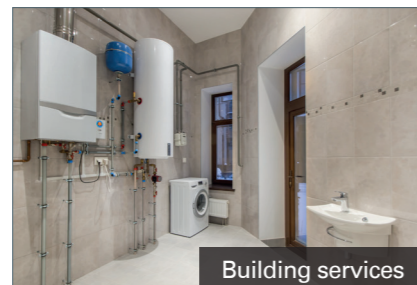
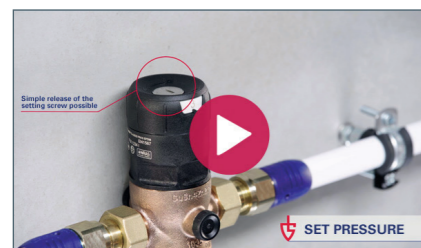

SERIES 9040

Pressure reducing valve

made of stainless steel, with threaded connections

The 9000 series is as the 9040 series, made of stainless steel. The V4A stainless steel housing does not release any harmful substances into the potable water and is corrosion-resistant for all water qualities. The corrosion resistant material is also suitable for aggressive media.

The stainless steel version is used, for example, in systems for processing foodstuffs, cosmetics, beverages or other complex media.

The pressure reducing valve also has an easy-to-clean filter screen with a transparent filter cup to protect the downstream system, the high-performance plastic valve insert and the setting scale visible from 2 angles.

A filter cup made of V4A is also available as an alternative for hot water and PN25 applications.

Also in this case, the valve insert is made entirely of plastic and the user enjoys all the benefits from all the advantages of the 9000 series in combination with those of V4A stainless steel.

 **Temperatures**
from +5°C to +85°C

 **Inlet pressure up to 25 bar, Outlet pressure adjustable**
from 0,5 bar to 12 bar

 **Threaded connections**
from ½" to 2"



+ ADVANTAGES OF THIS SERIES

V4A stainless steel housing

high-quality plastic

flow optimisation permits a higher maximum flow rate

160 µm fine screen insert

transparent filter cup

setting scale visible from two angles

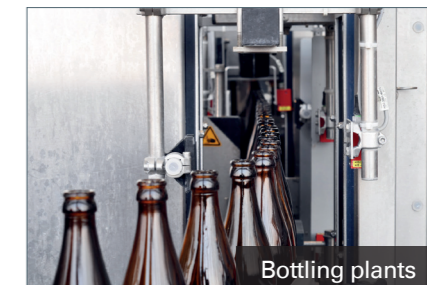

LEAD-FREE GUNMETAL RG+

The lead-free gunmetal RG+ is the result of consistent development from the lead-containing gunmetal RG 5 lead-reduced CuSn5Zn5Pb2-C, which has proven itself for years. It is the preferred material for drinking water installations.

Inside the microstructure, lead has been substituted by sulphur, however it has no effect on the basic properties such as excellent corrosion resistance, tensile strength, elongation, hardness and machinability.

The new RG+ material was extensively tested in the laboratory and over several years in the field. The alloy is standardised by DIN SPEC 2701 and part of the Federal Environment Agency's positive list of metallic materials suitable for drinking water hygiene since 2018.

As well as for the conventional gunmetal, a high tin content in the new alloy ensures the optimum coating structure. In addition to high corrosion resistance it also guarantees long-term safety.

Therefore, the lead-free gunmetal RG+ can be used in all water qualities according to the drinking water ordinance and according to all drinking water-related standards in Europe without any restrictions.

The material has excellent hygienic properties. With a maximum lead content of 0.10% the requirements of national and international legislation, such as for the US are met and is also compliant to the REACH regulation, and will certainly meet future material requirements as well.



FUNCTIONS IDEALLY SUPPORTED BY AN INNOVATIVE DESIGN

Goetze is exploring new avenues not only in product development but its products are constantly advancing in terms of design as well. The pressure reducing valve sets itself apart, above all, through an integrated filter, a conveniently-shaped adjustment handle and a clearly arranged scale for setting the desired outlet pressure. Goetze is also breaking new ground in the field of materials. For the very first time, the company is making extensive use of plastics, the transparent filter cup, for example, being made exclusively of high-quality plastic.



OFFERING EVEN MORE BENEFITS THROUGH PLASTIC

The new pressure reducing valve consists of a combination of materials unique for Goetze. As with numerous other products, the housing is made of gunmetal. Which is lead-free and offers the highest possible corrosion resistance.

The elimination of lead offers further benefits: The environment is sustainably protected by the avoidance of heavy metals and future-proof recyclability is possible.

The use of selected plastics from medical technology, however, is new: for such components as the spring housing, the adjustment handle as well as in the filter cup and associated filter. The valve insert is even made of a plastic that is mainly used in medical technology.

The materials used set themselves apart in particular through high strength, hardness and rigidity even at high temperatures. In addition, plastics suffer little to no cavitation at all. But there is also enormous creative leeway in terms of the design itself. You benefit, for example, from the high degree of transparency that allows soiling to be detected quickly and the pressure reducing valve to be maintained accordingly.

By expanding the material combination, the user benefits from the positive properties of the plastic without having to forego the usual quality for which Goetze KG is known.

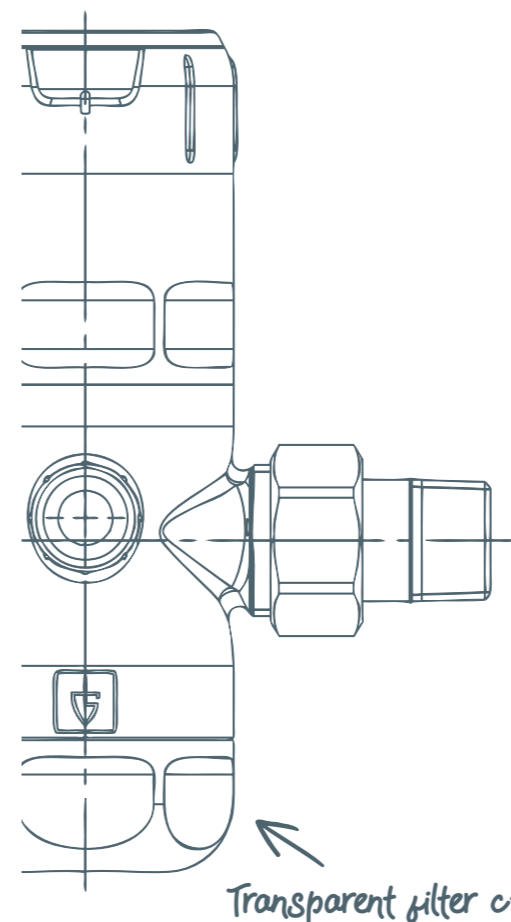



SERIES 382

Pressure reducing valve

made of spheroidal graphite cast iron,
with flange connections

+ ADVANTAGES OF THIS SERIES

adjustment scale in the bonnet

housing with polyamide coating
offers highest corrosion
resistance

valve insert made of V4A
stainless steel

two glycerine-filled pressure
gauges and flange seals made of
EPDM with steel core

The 382 pressure reducing valve is used in a wide variety of water applications. Whether in apartment buildings, office complexes, hospitals or hotels - wherever larger quantities of water are needed, it regulates the pressure excellently. Due to its low pressure drop, the pressure reducing valves 382 is even used in municipal water supply.

Only high-quality, approved materials are used for the pressure reducing valve 382. Thanks to its body made of spheroidal graphite cast iron the pressure reducing valves 382 is ideally equipped to withstand mechanical stresses in the installation.

Its high-quality polyamide coating applied in a dipping process, offers maximum corrosion resistance – even against sea-water and abrasive water.

The valve insert made of V4A stainless steel can be removed quickly and easily for maintenance.

For easy backpressure adjustment without operating pressure, the flanged pressure reducer is equipped with an adjustment scale in the spring housing.

 **Temperatures**
from +5°C to +65°C

 **Inlet pressure** up to 25 bar,
Outlet pressure
from 0,5 bar to 12 bar

 **Flange connections**
from DN 50 to DN 125



Water supply



Buildings

SERIES 9160

Pressure reducing valve

made of brass,
with threaded connections



+ ADVANTAGES OF THIS SERIES

integrated filter sieve

adjustment scale for pressureless
presetting with a screwdriver

housing made of dezincificati-
on-resistant brass

The 9160 series - the smallest water pressure reducing valves in the Goetze portfolio.

These mini pressure reducing valves in Nominal diameter DN 8 are used especially in applications such as coffee machines, water dispensers or soft drink dispensers with fixed water connections. The small size is particularly important here, since the pressure reducing valves are often integrated into the integrated into the body of the unit.

In flat water installations, the mini pressure reducing valves are often used in Nominal diameter DN 15 and DN 20.

The integrated filter screen protects the unit and the installation from particles and impurities. An adjustment scale in the spring housing enables pressureless presetting with a screwdriver.

Nominal diameters DN 15 and DN 20 can be installed with optionally available fitting screw connections. Alternatively, directly by means of a female thread.

The body is made of Dezincification resistant brass - also available in lead-free brass on request. Fittings and pressure gauges are available as accessories.

 **Temperatures**
from +5°C to +60°C

 **Inlet pressure** up to 16 bar,
Outlet pressure
from 1 bar to 6 bar

 **Threaded connections**
from 3/8" to 3/4"



Coffee machine



Water dispenser

SERIES 481 & 681

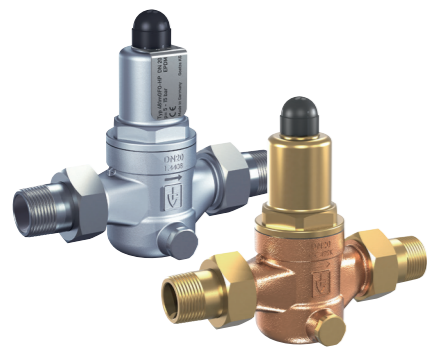

Pressure reducing valve

made of stainless steel and gunmetal,
with threaded connections

The tried and tested, robust pressure reducing valves in full metal design with screwed connections have proven themselves not only in the drinking water sector, but especially under harsh operating conditions in the industrial sector for a wide variety of media, including aggressive media, and at fluctuating ambient temperatures. The materials are optimised for a wide range of water qualities and hot water applications.

In addition to the standard setting range of 1 to 8 bar, a wide range of applications is served by the additional backpressure ranges of 0.5 to 2 bar and 5 to 15 bar.

Optionally available with female thread.

 **Temperatures**
from -20°C to +120°C

 **Inlet pressure** up to 40 bar,
Outlet pressure adjustable
from 0,5 bar to 15 bar

 **Threaded connections**
from ½" to 2"

SERIES 482 & 682

Pressure reducing valve

made of stainless steel and gunmetal,
with flange connections

Fittings often require flange connections. This is the exact reason for our series in the nominal diameter ranges of DN 15 up to DN 100. Besides the standard versions of these pressure reducing valves made of stainless steel and gunmetal, the valves are also available in nominal diameters from DN 20 to DN 50 in high-pressure and a low-pressure version. Upon request we can also equip the stainless steel pressure reducing valves for various pressure ranges with stainless steel pressure gauges.

For highest service-friendliness also in the case of the flange versions, a replacement internal cartridge with integrated dirt trap is available.

 **Temperatures**
from -20°C to +120°C

 **Inlet pressure** up to 40 bar,
Outlet pressure adjustable
from 0,5 bar to 15 bar

 **Flange connections**
from DN 15 to DN 100



SERIES 651mW

Diaphragm safety valve

made of gunmetal, angle type,
with threaded connections

651mWnk enlarged outlet (TÜV/CE)

651mWIK with inlet and outlet diameter equal

Particularly in the case of valves which are employed in potable water installations, we do not accept any compromises regarding the materials used.

Only the highest quality materials suitable and approved for potable water applications are used in these valves.

These types of safety valves with diaphragm are installed in the cold water pipe before the hot water heater to protect it from inadmissible overpressure.

 **Temperatures**
from -10°C to +95°C

 **Pressures**
from 3 bar to 10 bar

 **Threaded connections**
from ½" to 1 ¼"



PRESSURE REDUCING VALVE – SIMPLY EXPLAINED

Assembly instructions are also available as a video

Pressure reducing valve – Installation, maintenance and function simply explained with our assembly video. See how the pressure reducing valve is fitted in a line with threaded connections and how it then works. With a fascinating view into the valve itself and flow graphics.

Watch the pressure reducing valve video now!

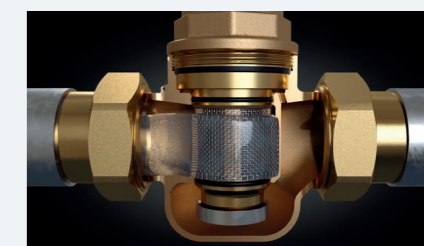

THE GOETZE KG

Individuality for more safety

The competence of Goetze KG Armaturen has been in demand for 70 years. Our wealth of experience is as broad and varied as our areas of application for our high-performance fittings. Our well thought-out family of products covers every industrial application: Liquids of all kinds, gases, technical vapours and steam. Goetze valves are used with temperatures ranging from $-270\text{ }^{\circ}\text{C}$ up to $+400\text{ }^{\circ}\text{C}$ and the greatest possible safety is a priority.

At any time, you can reach a competent contact partner as part of our in-house team at Goetze. Whether it is for the product selection, the configuration of the right valve, urgent requests, whether per telephone call or per mail, there is a personal multilingual consultant at your disposal. With over 500.000 valves per year „Made in Germany“, we are your competent partner for all matters relating to the handling of pressure.



Goetze KG Armaturen

Robert-Mayer-Straße 21
71636 Ludwigsburg

Fon: +49 (0) 7141 / 488 94 60
Fax: +49 (0) 7141 / 488 94 88

info@goetze.de
www.goetze-group.com